



## Frame Mounted Tool Boxes



Diamond Plate Double Door

Diamond Plate Single Door

Smooth Single Door

Smooth Double Door

- Constructed of high strength/low weight aluminum.
- Protective coating on smooth doors for improved shipping protection (to be removed at time of installation.)
- 4 Standard base models.
- Polished stainless steel T-handle latches with locks.
- Doors available in smooth finish or diamond plate. All smooth doors are polished to a #8 grade for an exceptional appearance.
- Stainless steel piano style hinge.
- Stainless steel doors are available by special order.
- Custom sizes and designs are available to meet specific needs.
- Door lanyards and shelf options available. Call customer service.
- Stocked in most Merritt warehouse locations.

Models and/or Specifications Subject to Change Without Notice.





## SMOOTH DOORS

PART#	DIM. HxWxL & DESCRIPTION	WT.
201	18"x18"x18" Single Door	25
203	18"x18"x24" Single Door	36
205	18"x18"x30" Single Doors	42
207	18"x18"x36" Single Door	48
287	18"x18"x36" Double Door	49
209	18"x18"x48" Single Door	60
211	18"x18"x48" Double Door	61
289	18"x18"x60" Single Door	69
291	18"x18"x60" Double Door	70
213	24"x24"x24" Single Door	47
215	24"x24"x30" Single Door	56
217	24"x24"x36" Single Door	64
235	24"x24"x36" Double Door	61
219	24"x24"x48" Single Door	77
221	24"x24"x48" Double Door	79
223	24"x24"x60" Single Door	105
225	24"x24"x60" Double Door	107
293	18"x24"x48" Single Door	66
295	18"x24"x48" Double Door	67
297	18"x24"x60" Single Door	87
299	18"x24"x60" Double Door	88

\*Stainless steel Door Option Available.

## DIAMOND PLATED DOORS

PART#	DIM. HxWxL & DESCRIPTION	WT.
202	18"x18"x18" Single Door	25
204	18"x18"x24" Single Door	36
206	18"x18"x30" Single Doors	42
208	18"x18"x36" Single Door	48
288	18"x18"x36" Double Door	49
210	18"x18"x48" Single Door	60
212	18"x18"x48" Double Door	61
290	18"x18"x60" Single Door	69
292	18"x18"x60" Double Door	70
214	24"x24"x24" Single Door	47
216	24"x24"x30" Single Door	56
218	24"x24"x36" Single Door	64
236	24"x24"x36" Double Door	61
220	24"x24"x48" Single Door	77
222	24"x24"x48" Double Door	79
224	24"x24"x60" Single Door	105
226	24"x24"x60" Double Door	107
294	18"x24"x48" Single Door	66
296	18"x24"x48" Double Door	67
298	18"x24"x60" Single Door	87
300	18"x24"x60" Double Door	88

\*Custom Designs & Sizes Available.

## TOOL BOX OPTIONS

OPTION#	DIM. HxWxL & DESCRIPTION	WT.
1518	18" Lanyard Kit, Tool Box	1
1519	18" Lanyard Kit, Tool Box	1
1824	Shelf, Bolt-in, for 18"x24" Tool Box	7
1830	Shelf, Bolt-in, for 18"x30" Tool Box	10
1836	Shelf, Bolt-in, for 18"x36" Tool Box	12
1848	Shelf, Bolt-in, for 18"x48" Tool Box	16
1860	Shelf, Bolt-in, for 18"x60" Tool Box	23
2424	Shelf, Bolt-in, for 24"x24" Tool Box	10
2430	Shelf, Bolt-in, for 24"x30" Tool Box	12
2436	Shelf, Bolt-in, for 24"x36" Tool Box	15
2448	Shelf, Bolt-in, for 24"x48" Tool Box	19
2460	Shelf, Bolt-in, for 24"x60" Tool Box	23

## ZINC PLATED STEEL MOUNTING BRACKETS

PART#	DIM. HxWxL & DESCRIPTION	A	B	WT.
117	For 18" Deep Tool Box	23-13/16"	16"	18
118	For 24" Deep Tool Box	29-13/16"	22"	25
620	E-Z Mounting Kit for 18" Tool Boxes	23-13/16"	16"	24
621	E-Z Mounting Kit for 24" Tool Boxes	29-13/16"	22"	31

- All Steel for strength and low cost, Zinc Plated for lasting good looks!
- Available for 18" or 24" deep Tool Boxes.
- Lightweight design - 117 only 18 lbs, 118 only 25 lbs.

- UHMW Plastic used on striker plate for longer latch assembly life and easier operation.
- Automotive grade door seals, secures the entire perimeter, for a more water resistant seal
- Merritt's extruded door frame provides a weather resistant seal.
- Lap joint weld provides material overlap in the corner where it is needed for superior strength and longer life (compared to most boxes that are constructed with butt welds).

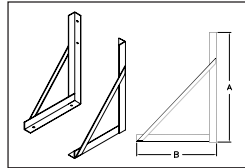

- Vertical angle is high strength alloy and 1/4" thick.

Call the Merritt Customer Service Team with questions & clarification. 800.525.0107



## Stackable Aluminum Boxes



- Mount under body, on top of the deck, side-by-side – the door will open.
- Constructed of high strength/low weight aluminum.
- 42 Standard base models.
- Polished stainless steel T-handle latches with locks.
- Doors available in smooth finish or diamond plate. All smooth doors are polished to a #8 grade for an exceptional appearance.
- Bullet style hinge with 1/4" Stainless steel center pin.
- Protective coating on smooth doors are improved shipping protection (to be removed at time of installation).
- Stainless steel doors are available by special order.
- Custom sizes and designs are available to meet specific needs.

Models and/or Specifications Subject to Change Without Notice.





## SMOOTH DOORS

PART#	DIM. HxWxL & DESCRIPTION	WT.
3573	18"x17-3/16"x18" Single Door	24
3575	18"x17-3/16"x24" Single Door	36
3577	18"x17-3/16"x30" Single Doors	42
3579	18"x17-3/16"x36" Single Door	48
3581	18"x17-3/16"x36" Double Door	49
3583	18"x17-3/16"x48" Single Door	60
3585	18"x17-3/16"x48" Double Door	61
3587	18"x17-3/16"x60" Single Door	69
3589	18"x17-3/16"x60" Double Door	70
3613	18"x23-3/16"x48" Double Door	66
3609	18"x23-3/16"x48" Single Door	67
3615	18"x23-3/16"x60" Single Door	87
3617	18"x23-3/16"x60" Double Door	88
3593	24"x23-3/16"x24" Single Door	47
3595	24"x23-3/16"x30" Single Door	56
3597	24"x23-3/16"x36" Single Door	64
3599	24"x23-3/16"x36" Double Door	61
3601	24"x23-3/16"x48" Single Door	77
3603	24"x23-3/16"x48" Double Door	79
3607	24"x23-3/16"x60" Double Door	105
3605	24"x23-3/16"x60" Single Door	107

\*Stainless steel Door Option Available.

## DIAMOND PLATED DOORS

PART#	DIM. HxWxL & DESCRIPTION	WT.
3570	18"x17-3/16"x18" Single Door	25
3572	18"x17-3/16"x24" Single Door	36
3574	18"x17-3/16"x30" Single Door	42
3576	18"x17-3/16"x36" Single Door	48
3578	18"x17-3/16"x36" Double Door	49
3582	18"x17-3/16"x48" Single Door	60
3584	18"x17-3/16"x48" Double Door	61
3588	18"x17-3/16"x60" Single Door	69
3586	18"x17-3/16"x60" Double Door	70
3608	18"x23-3/16"x48" Single Door	47
3612	18"x23-3/16"x48" Double Door	56
3614	18"x23-3/16"x60" Single Door	64
3616	18"x23-3/16"x60" Double Door	61
3590	24"x23-3/16"x24" Single Door	77
3592	24"x23-3/16"x30" Single Door	79
3594	24"x23-3/16"x36" Single Door	105
3596	24"x23-3/16"x36" Double Door	107
3600	24"x23-3/16"x48" Single Door	66
3602	24"x23-3/16"x48" Double Door	67
3604	24"x23-3/16"x60" Single Door	87
3606	24"x23-3/16"x60" Double Door	88

\*Custom Designs & Sizes Available.

## TOOL BOX OPTIONS

OPTION#	DESCRIPTION	WT.
3546	Kit, Gas Shock and Mount for S-Series and STD Tool Boxes	6
1518	18" Lanyard Kit, Tool Box	1
1519	24" Lanyard Kit, Tool Box	1

## ZINC PLATED STEEL MOUNTING BRACKETS

PART#	DIM. HxWxL & DESCRIPTION	A	B	WT.
117	For 18" Deep Tool Box	23-13/16"	16"	18
118	For 24" Deep Tool Box	29-13/16"	22"	25
620	E-Z Mounting Kit for 18" Tool Boxes	23-13/16"	16"	24
621	E-Z Mounting Kit for 24" Tool Boxes	29-13/16"	22"	31

- All Steel for strength and low cost, Zinc Plated for lasting good looks!
- Available for 18" or 24" deep Tool Boxes.
- Lightweight design - 117 only 18 lbs, 118 only 25 lbs.

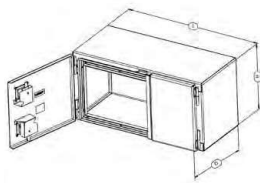

- UHMW Plastic used on striker plate for longer latch assembly life and easier operation.
- Automotive grade door seals, secures the entire perimeter, for a more water resistant seal
- Merritt's extruded door frame provides a weather resistant seal.
- Lap joint weld provides material overlap in the corner where it is needed for superior strength and longer life (compared to most boxes that are constructed with butt welds).

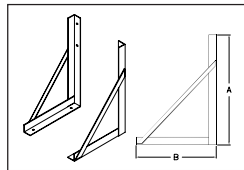

- Vertical angle is high strength alloy and 1/4" thick.

Call the Merritt Customer Service Team with questions & clarification. 800.525.0107



## Cam Lock Tool Boxes



- Constructed of high durable/light weight aluminum.
- Protective coating on smooth doors for improved shipping protection (to be removed at time of installation).
- Latch hardware is aluminum electro-polished for superior finish.
- Doors available in smooth finish or diamond plate.
- 2" stainless steel hinge.
- Stainless steel doors are available by special order.
- Shelf options available.
- Boxes are available in 18" and 24" heights.
- Custom depth and length are available to meet specific needs.

Models and/or Specifications Subject to Change Without Notice.





## CAM LOCK BOX Smooth Doors

PART#	DIM. HxWxL & DESCRIPTION	WT.
6500	18"x18"x36" Double Door	49
6502	18"x18"x48" Double Door	61
6504	18"x18"x60" Double Door	70
6506	18"x24"x36" Double Door	54
6508	18"x24"x48" Double Door	67
6510	18"x24"x60" Double Door	88
6512	24"x24"x36" Double Door	61
6514	24"x24"x48" Double Door	79
6516	24"x24"x60" Double Door	107

## CAM LOCK BOX Diamond Plate Doors

PART#	DIM. HxWxL & DESCRIPTION	WT.
6501	18"x18"x36" Double Door	50
6503	18"x18"x48" Double Door	62
6505	18"x18"x60" Double Door	71
6507	18"x24"x36" Double Door	55
6509	18"x24"x48" Double Door	68
6511	18"x24"x60" Double Door	89
6513	24"x24"x36" Double Door	62
6515	24"x24"x48" Double Door	80
6517	24"x24"x60" Double Door	108

## CAM LOCK BOX OPTIONS

OPTION#	DIM. HxWxL & DESCRIPTION	WT.
1836	Shell, Bolt-In, for 18"x36" Tool Box	12
1848	Shell, Bolt-In, for 18"x48" Tool Box	16
1860	Shell, Bolt-In, for 18"x60" Tool Box	23
2436	Shell, Bolt-In, for 24"x36" Tool Box	15
2448	Shell, Bolt-In, for 24"x48" Tool Box	19
2460	Shell, Bolt-In, for 24"x60" Tool Box	23

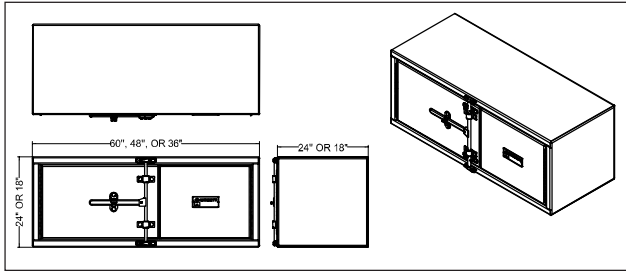

- Automotive grade door seals, secures the entire perimeter, for a more water resistant seal.
- Lap joint weld provides material overlap in the corner where it is needed for superior durability and longer life (compared to most boxes that are constructed with butt weld).

## ZINC PLATED STEEL MOUNTING BRACKETS

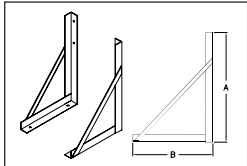

PART#	DIM. HxWxL & DESCRIPTION	A	B	WT.
117	For 18" Deep Tool Box	23-13/16"	16"	18
118	For 24" Deep Tool Box	29-13/16"	22"	25
620	E-Z Mounting Kit for 18" Tool Boxes	23-13/16"	16"	24
621	E-Z Mounting Kit for 24" Tool Boxes	29-13/16"	22"	31

- Vertical angle is high strength alloy and 1/4" thick. Lightweight design..
- All Steel for strength and low cost, Zinc Plated for lasting good looks!
- Available for 18" or 24" deep Tool Boxes.
- Lightweight design - 117 only 18 lbs, 118 only 25 lbs.



Call the Merritt Customer Service Team with questions & clarification. 800.525.0107

Models and/or Specifications Subject to Change Without Notice.

## Saddle Boxes & Other Storage Boxes



- Utilize unused frame space and add additional storage areas.
- Heavy Duty designs on all storage boxes for longer life.
- Aluminum for low weight, yet high strength.
- 18 different models to make the most of your frame space.
- Saddle Boxes now available with optional internal chain rack or dividers.
- Saddle Boxes available with or without steps.
- Extruded door frame with full perimeter automotive door seal for a water resistant closure.
- Mounting Kit welded inside all 12", 18", 24" & 30" Saddle Boxes (bolts not included.)
- 36" Saddle Box must be mounted using external brackets (480 & 481 use bracket 117, 482 & 483 use bracket 118).

Models and/or Specifications Subject to Change Without Notice.



## SMOOTH DOORS

PART#	DIM. HxWxL & DESCRIPTION	WT.
450	22" x 21" x 12"	27
452	23-1/2" x 28-1/2" x 12" w/ step	34
460	22" x 21" x 18"	32
462	23-1/2" x 28-1/2" x 18" w/ step	42
470	22" x 21" x 24"	43
472	23-1/2" x 28-1/2" x 24" w/ step	56
480*	22" x 21" x 36"	56
482*	23-1/2" x 28-1/2" x 36" w/ step	76
478	22" x 21" x 30"	50
488	23-1/2" x 28-1/2" x 30" w/ step	67

\* Model 117 or 118 Mounting Kit Required.

## DIAMOND PLATED DOORS

PART#	DIM. HxWxL & DESCRIPTION	WT.
451	22" x 21" x 12"	27
453	23-1/2" x 28-1/2" x 12" w/ step	34
461	22" x 21" x 18"	32
463	23-1/2" x 28-1/2" x 18" w/ step	43
471	22" x 21" x 24"	44
473	23-1/2" x 28-1/2" x 24" w/ step	57
481*	22" x 21" x 36"	57
483*	23-1/2" x 28-1/2" x 36" w/ step	77
477	22" x 21" x 30"	52
487	23-1/2" x 28-1/2" x 30" w/ step	69

\* Model 117 or 118 Mounting Kit Required.

## CHAIN KIT RACK

OPTION#	DIM. HxWxL & DESCRIPTION	WT.
486-1	Saddle Box Chain Rack, 12"	1
486-2	Saddle Box Chain Rack, 18"	1
486-3	Saddle Box Chain Rack, 24"	1
486-4	Saddle Box Chain Rack, 36"	1

## Saddle Box Divider

OPTION#	DIM. HxWxL & DESCRIPTION	WT.
485-1	Saddle Box Divider Set, 12"	2
485-2	Saddle Box Divider Set, 18"	2
485-3	Saddle Box Divider Set, 24"	2
485-4	Saddle Box Divider Set, 36"	2

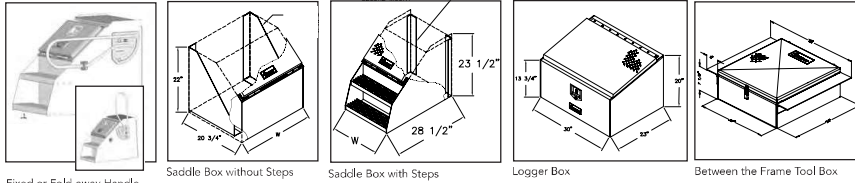

## Saddle Box Folding & Fixed Handles

PART#	DIM. HxWxL & DESCRIPTION	WT.
3518	Folding Handle R/H	11
3519	Folding Handle L/H	11
3524	Fixed Handle R/H	5
3525	Fixed Handle L/H	5

Mounts to any Merritt Saddle Box.

## Logger Box

Easy cross frame mounting kit is included. Can be side-frame mounted using #118 mounting kit.

PART#	DIM. HxWxL & DESCRIPTION	WT.
229	Logger Box w/ Cross Frame Mounting Kit: 20" x 23" x 30"	54

## Between-the Frame Tool Box

Easy installation using clamps - no drilling of the frame. Mounting kit included.

PART#	DIM. HxWxL & DESCRIPTION	WT.
253	Diamond Plate Door w/ Mounting Kit: 22" x 9" x 24"	36

## ZINC PLATED STEEL MOUNTING BRACKETS

PART#	DIM. HxWxL & DESCRIPTION	A	B	WT.
117	For 18" Deep Tool Box	23-13/16"	16"	18
118	For 24" Deep Tool Box	29-13/16"	22"	25
620	E-Z Mounting Kit for 18" Tool Boxes	23-13/16"	16"	24
621	E-Z Mounting Kit for 24" Tool Boxes	29-13/16"	22"	31

- All Steel for strength and low cost, Zinc Plated for lasting good looks!
- Available for 18" or 24" deep Tool Boxes.
- Lightweight design - 117 only 18 lbs, 118 only 25 lbs.

Call the Merritt Customer Service Team with questions & clarification. 800.525.0107





# Top Opening Saddle Boxes



- 20 different sizes to choose from
- Available in smooth aluminum or diamond plate doors
- With or without steps in all sizes
- Top step opens along with the door for convenient storage of larger items
- Internal mounting included on boxes up to 24" wide
- Interior chain racks and dividers available separately
- Locking T-Handle latch comes with dust cover and 2 keys
- Can use external L-Brackets for added mounting strength
- Optional grab handles available separately
- Extruded door frame for added strength
- Full perimeter automotive door seal for water resistant closure
- High quality shock assembly for long lasting use
- Strong Bullet hinge

### SMOOTH FINISH

PART#	DIM. HxWxL & DESCRIPTION	WT.
6450	22"x21"x12"	41
6452	23.5"x28.5"x12" w/ Step	49
6460	22"x21"x18"	56
6462	23.5"x28.5"x18" w/ Step	68
6470	22"x21"x24"	57
6472	23.5"x28.5"x24" w/ Step	87
6478	22"x21"x30"	72
6480	22"x21"x36"	80
6482	23.5"x28.5"x36" w/ Step	107
6488	23.5"x28.5"x30" w/ Step	98

### DIAMOND PLATED

PART#	DIM. HxWxL & DESCRIPTION	WT.
6451	22"x21"x12"	41
6453	23.5"x28.5"x12" w/ Step	49
6461	22"x21"x18"	56
6463	23.5"x28.5"x18" w/ Step	68
6471	22"x21"x24"	57
6473	23.5"x28.5"x24" w/ Step	87
6477	22"x21"x30"	72
6481	22"x21"x36"	80
6483	23.5"x28.5"x36" w/ Step	107
6487	23.5"x28.5"x30" w/ Step	98

Models and/or Specifications Subject to Change Without Notice.



## DEF Storage Boxes

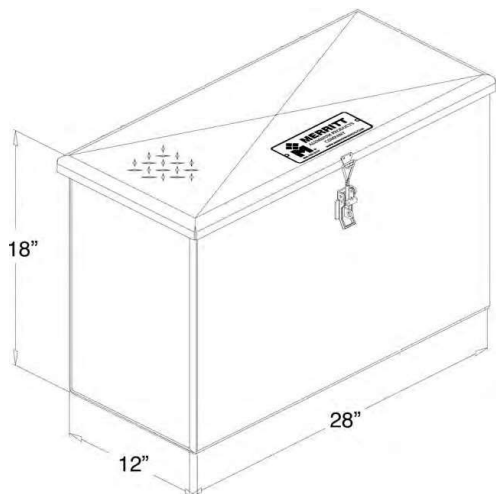

- The DEF Box will carry up to four, one gallon DEF jugs or two 2.5 gallon jugs.
- Mounting Kit is welded inside and can be mounted from either end.
- Mounting brackets are welded in each end, you can mount the box from either end
- Utilizes an "Over Center" latch with padlock.
- Utilize unused frame space and add outside storage for your DEF Products.
- Heavy Duty designs on all DEF boxes for longer life.
- Utilizing Merritt's "Bullet" hinge with 1/4" stainless steel pivot, for no trouble – long life.
- Aluminum for low weight, yet high strength.

### DEF STORAGE BOXES

PART#	DIM. HxWxL & DESCRIPTION	WT.
3630	18"x28"x12" DEF Box, Aluminum with Diamond Plate Door	*34



Call the Merritt Customer Service Team with questions & clarification. 800.525.0107



## Cab Access Boxes



- 5 Models for more application choices.
- High-grade aluminum alloy for low weight & high strength, delivering longer box life.
- Extruded frame step for strength and product life.
- Constructed with the same Merritt tool box features that have time proven designs for a longer product life, less life cycle cost.
- Extruded door frame & automotive door seal on the storage box give a more water resistant seal and added strength.
- Replaceable Steps on all step models.
- Bright Aluminum & Stainless steel door and lid are available as a custom option.

Models and/or Specifications Subject to Change Without Notice.





- High-grade aluminum alloy construction for low weight, yet high strength to deliver longer box life.
- Door opening is constructed using an extruded door frame for additional strength.
- Automotive door seal for a water resistant seal.
- Replaceable steps.
- With the optional #496 mounting brackets, you can install these boxes on most truck frames.

## CAB ACCESS SIDE STORAGE BOXES

PART#	DIM. HxWxL & DESCRIPTION	WT.
492	18" x 28-7/8" x 30-1/8" Complete with Steps	60
493	15-3/4" x 23" x 30-1/8" Without Steps	49
494	18" x 28-7/8" x 24" Complete with Step	57
495	16-1/4" x 23" x 24" Without Steps, Driver Side	43
498	18" x 28-7/8" x 2" Complete With Steps	67

## CAB STORAGE BOX OPTIONS

PART#	DESCRIPTION	WT.
496	Mounting Angles	20
497	Battery Hold Down Kit	5

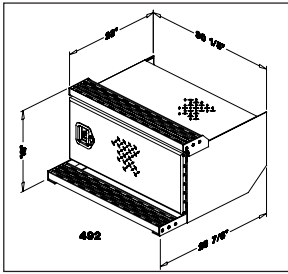

#492

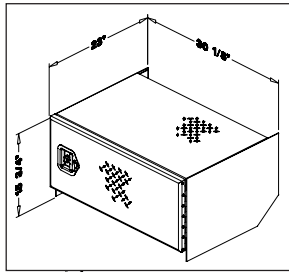

#493

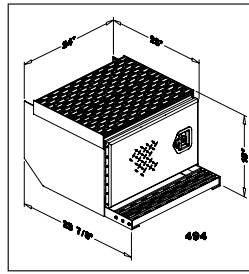

#494

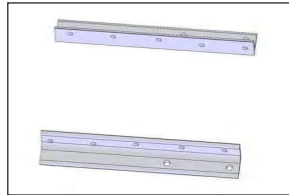

#496



Call the Merritt Customer Service Team with questions & clarification. 800.525.0107

Models and/or Specifications Subject to Change Without Notice.

## Battery Boxes

### STACK PACK SERIES



- Five styles to choose from, to aid in your installation process.
- Four side frame mounts and two in-frame mount.
- Made from a strong, yet light- weight Aluminum alloy, for long life and weight savings.
- Side frame units can mount using a frame drill bracket or a No-Drill kit that does not need to drill the frame. This allows for a savings in installation time.
- All models of battery boxes are stocked In various Merritt Warehouse locations.
- In-Frame box does not require any frame drilling to mount, saving installation time. Comes with mounting kit.
- All boxes come with or have an optional battery hold down kit . You do not need to spend time on how to mount the batteries.

Models and/or Specifications Subject to Change Without Notice.



- Battery Boxes will hold two, four or six group 31 batteries.
- High-grade aluminum alloy construction for low weight, yet high strength to deliver longer Box life.

## SIDE-PACK BOX

PART#	DESCRIPTION	DIM: HxWxL	WT.
490	Side Battery Box	18" x 28-7/8" x 30-1/8"	50
491	2 Battery Box, Vertical w/Step	16-1/4" x 23" x 30-1/8"	54

\* Without Steps (See below for mounting & battery hold down kits)

## STACK-PACK BOX

PART#	DESCRIPTION	DIM: HxWxL	WT.
3552	2 Battery Box, Vertical	24" x 20" x 10"	50
3561	2 Battery Box, Vertical w/Step	24" x 28" x 10"	54
3521-1	2 Battery Box, Horizontal	12" x 20" x 16"	35
3562-1	2 Battery Box, Horizontal w/Step	13" x 15-1/2" x 16"	41
3503-1	4 Battery Box, Vertical	24" x 20" x 16"	60
3504-1	4 Battery Box w/Top Deck Plate, Vertical	25" x 20" x 16"	63
3556-1	4 Battery Box w/Step	25" x 25" x 16"	77
3514-1	6 Battery Box, Vertical	24" x 20" x 10"	77
3563	6 Battery Box, Vertical	24" x 20" x 10"	105

## FRAME-PACK BOX

PART#	DESCRIPTION	DIM: HxWxL	WT.
258	4 Battery In-Frame Battery Box*	12" x 23" x 27-3/4"	60
259	2 Battery In-Frame Battery Box	12" x 23" x 13-1/3"	28

\* With Hinged Lid. Includes Mounting and Battery Hold Down Kits.

## BATTERY BOX OPTIONS

PART#	DESCRIPTION	WT.
3507	No-Drill Mounting Kit	28
496	Frame Drill Mounting Kit	21
497	Battery Hold Down Kit (490, 491)	5

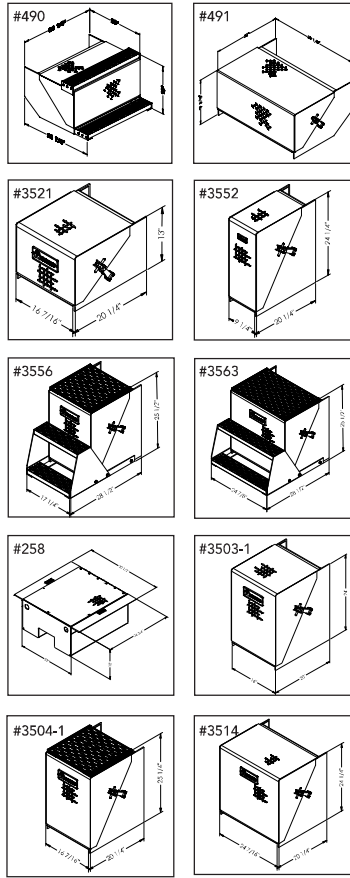

Call the Merritt Customer Service Team with questions & clarification. 800.525.0107

Models and/or Specifications Subject to Change Without Notice.



## E-Z No-Drill Toolbox Mounting Kit



#620 for 18" Deep Boxes  
#621 for 21" Deep Boxes



Clamps to flange,  
no frame drilling!



All hardware for the installation  
is included in the kit.



Secure, FAST to install  
and looks good.



- New system requires no drilling of the frame to mount.
- Strong, durable, easy to install.
- A quick and simple solution to drilling the frame.
- Easy to move from truck to truck.
- Fits all Merritt side mount Toolboxes.
- All steel parts are Zinc plated for longer life cycle.
- Load rating equal to the Merritt box rating being mounted.
- For those who do not wish to drill their frame.
- Normal hand tools used for installation.
- Stocked in most Merritt warehouse locations.

Models and/or Specifications Subject to Change Without Notice.



- Kit includes 1 right & 1 left "L" bracket and the E-Z Clamp
- Kit also includes all hardware to mount the brackets to the frame.
- Kit does not include the hardware to mount the box to the bracket.
- Must be installed to Merritt specifications, see mounting instructions

## MOUNTING KITS

PART#	DESCRIPTION	WT.
620	Mounting Kit for 18" tool boxes	24
621	Mounting Kit for 24" tool boxes	31

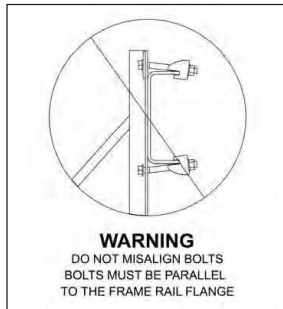
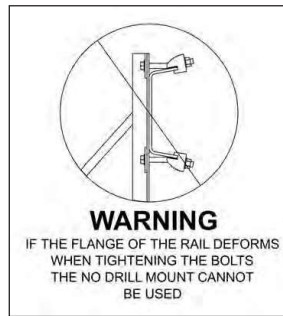
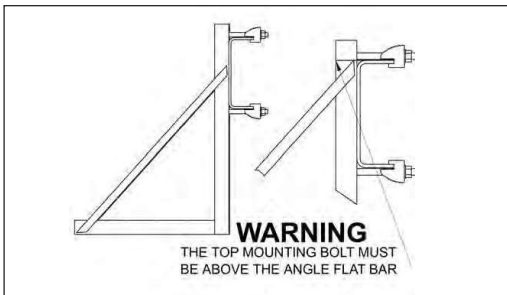
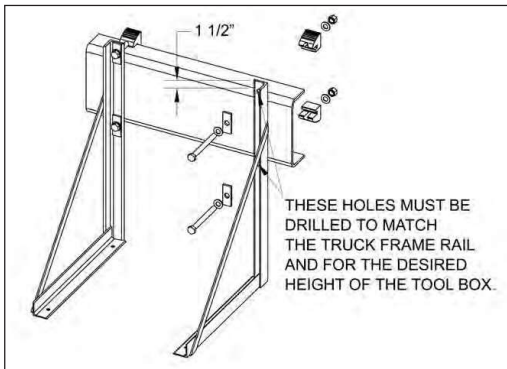

\* To be used on frames with a 7/16" flange thickness and smaller.



Call the Merritt Customer Service Team with questions & clarification. 800.525.0107





## Step Accessories & Connection Box



Frame Steps

Fairing Box

Two Models with Light Holes

Peterbilt® Style Tank Steps

Connection Box (Air & Electric Fittings Not Included.)

- **Frame Step:** Strong extruded aluminum nonslip tread 12", 18" and 24" models.
- **Pete Style Steps:** Fits the Peterbilt® 379 tanks (33.5" and 35.5" widths are standard for the 23" and 26" diameter tanks.)
- **Fairing Box:** Designed to fit between side fairing panel & truck frame
- **Connection Box:** Polished finish or Diamond Plate Aluminum, with or without light holes.
- Cross frame mount or can be mounted in the Merritt Dyna-Deck top mount, for a "custom" look.
- The Connection Box fits directly into the Dyna-Deck cover, if desired.

Models and/or Specifications Subject to Change Without Notice.



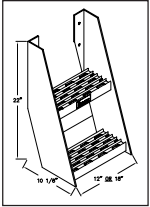

**FRAME STEPS**

PART#	DESCRIPTION	WT.
182	Frame Step - 12" Wide	9
362	Frame Step - 18" Wide	12
3000	Frame Step - 24" Wide	15

- Lower Step "foot stop - no shin bruises".
- Sturdy bolt design - light but strong.
- Bright aluminum throughout.

**FAIRING BOX**

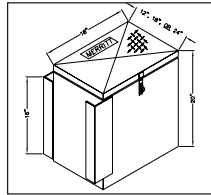

PART#	DIM. HxWxL & DESCRIPTION	WT.
254	20"x18"x12"	32
255	20"x18"x18"	37
256	20"x18"x24"	43

- Designed to fit between side fairing panel & truck frame.
- Unique mounting kit allows for easy installation without removing side fairings.
- Extruded door frame with automotive door seal for a water resistant closure.



**PETERBILT® STYLE TANK STEP**

PART#	DESCRIPTION & DIMENSION	WT.
3526	Tank Step - 23" Dia. x 33.5" Long	18
3527	Tank Step - 26" Dia. x 33.5" Long	18
3528	Tank Step - 23" Dia. x 35.5" Long	19
3520	Tank Step - 26" Dia. x 35.5" Long	19

(For Pete Model 379)

\*For other widths, please provide Diameter and Step Width.

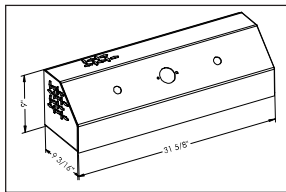

3533 - Diamond Plate with 2" Round Light Holes

**CONNECTION BOX**

PART#	DESCRIPTION	WT.
3529	Polished Aluminum w/ Air & Electric, No Light Holes	18
3530	Diamond Plate w/ Air & Electric, No Light Holes	18
3531	Polished with 5 (2") Round Light Holes	18
3532	Polished with 2 Oval Light Holes	18
3533	Diamond Plate w/ 5 (2") Round Light Holes	18
3534	Diamond Plate w/ 2 Oval Light Holes	18

Includes Mounting Hardware. Deck Cover Not Included. Add to 432, 433, 434 or 435 Deck Covers.



Call the Merritt Customer Service Team with questions & clarification. 800.525.0107



## Tire Chain Carriers



- Tire Chain Carrier: Frame mount lockable lid for security.
- Strong design to store up to 300 lbs of chains.
- 24" for open frames, 18" for frames with fairing packages.
- Tire Chain Carrier: Models with lid, without lid and with pull off lid available.
- You can purchase as singles or boxed in groups of 2, 3 or 4.
- Bulk Pricing available upon request.
- E-Z Hook, Tire Chain Carrier: Two models of hook. One for bolting to the frame, use (2) 1/2" grade 5 or better bolts. The other model is for bolting to the trailer cross member.

Models and/or Specifications Subject to Change Without Notice.





## TIRE CHAIN CARRIER: FRAME MOUNT

- Strong heavy duty design.
- Bright, smooth aluminum finish throughout
- Strong, light weight with bright finish for lasting good looks.

PART#	DESCRIPTION & DIMENSIONS	WT.
384-1	18" Chain Carrier w/Lid, 300 lb. capacity	22
233-1	24" Chain Carrier w/Lid, 300 lb. capacity	25
119	"No Drill" Mounting Kit (Fits 233 & 384)	4
385-1	18" Chain Carrier with 18" Removable Lid	22
234-1	24" Chain Carrier with 24" Removable Lid	22
3840	18" Chain Carrier No Lid	22
2330	24" Chain Carrier No Lid	22

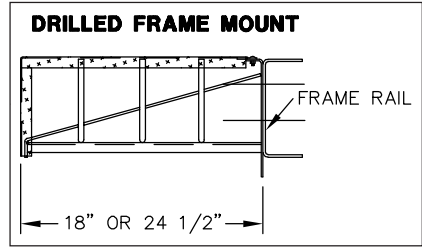
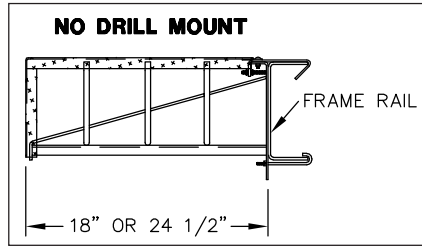

## E-Z HOOK, TIRE CHAIN CARRIER

PART#	DESCRIPTION & DIMENSIONS	WT.
3548	90 Degree Hook	4
3548-2	90 Degree Hook, 2 pack	8
3548-3	90 Degree Hook, 3 pack	12
3548-4	90 Degree Hook, 4 pack	16
3549	Flat Hook	4
3549-2	Flat Hook, 2 pack	8
3549-3	Flat Hook, 3 pack	12
3549-4	Flat Hook, 4 pack	16

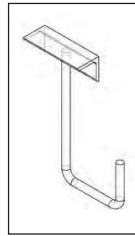
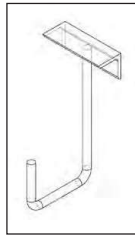
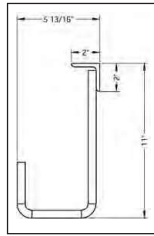

Part #3548 - Mounts to frame rail.

PART #3549 - Mounts to cross member of trailer.



Call the Merritt Customer Service Team with questions & clarification. 800.525.0107

Models and/or Specifications Subject to Change Without Notice.