

## Aluminum & Stainless Fenders

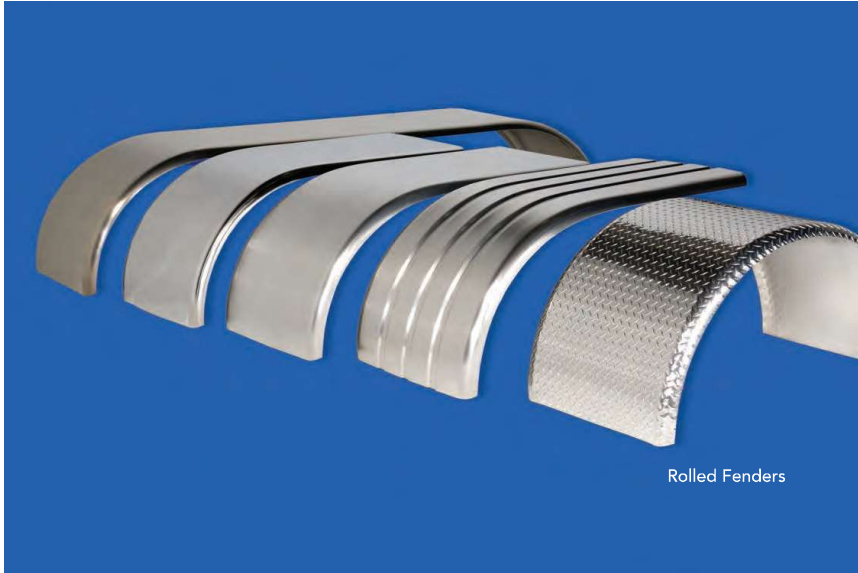

- Thirty-six models of fenders to fit most applications.
- Twelve different designs to cover your various needs.
- Stocked in most Merritt warehouse locations.
- Different styles and materials to choose from, allowing you to pick the “look” you want.
- Aluminum available in .090, .100DP or .125 thickness.
- 304 14ga stainless steel, #8 polish for strength and bright finish.
- Design a mounting style that will work for your truck.
- Custom lengths are available.
- Use the E-Z Mount Fender Bracket to install.

Models and/or Specifications Subject to Change Without Notice.



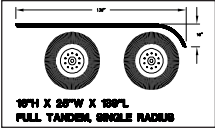

**10H X 25W X 18FL  
FULL TANDEN, SINGLE RADIUS**

PART#	DESCRIPTION	WT.
5001	.090 Smooth Alum. w/Ribs	35.4
5011	.090 Smooth Alum.	34.0
5021	.100 Diamond Plate Alum.	42.9
5031	.125 Smooth Alum.	47.1
5541	14 Gauge "Bright" S.S.	67.4



**10-1/2H X 25W X 45-1/2FL  
SINGLE AXLE, FULL RADIUS**

PART#	DESCRIPTION	WT.
5037	.090 Smooth Alum.	14.0

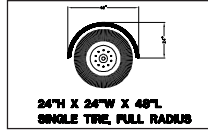

**24H X 24W X 45FL  
SINGLE TIRE, FULL RADIUS**

PART#	DESCRIPTION	WT.
5004	.090 Smooth Alum. w/Ribs	18.3
5014	.090 Smooth Alum.	17.6
5024	.100 Diamond Plate Alum.	22.0
5034	.125 Smooth Alum.	24.3
5544	14 Gauge "Bright" S.S.	34.8

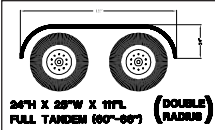

**24H X 25W X 11FL (DOUBLE)  
FULL TANDEN (60°-60°) (DOUBLE RADIUS)**

PART#	DESCRIPTION	WT.
5002	.090 Smooth Alum. w/Ribs	33.0
5012	.090 Smooth Alum.	31.9
5022	.100 Diamond Plate Alum.	38.3
5032	.125 Smooth Alum.	44.2
5542	14 Gauge "Bright" S.S.	64.1



**17H X 25W X 40-1/2FL  
SINGLE AXLE, FULL RADIUS**

PART#	DESCRIPTION	WT.
5035	.090 Smooth Alum.	11.1
5036	.125 Smooth Alum.	13.0



**24H X 25W X 53FL  
HALF TANDEN, SINGLE RADIUS**

PART#	DESCRIPTION	WT.
5000	.090 Smooth Alum. w/Ribs	15.6
5010	.090 Smooth Alum.	15.1
5020	.100 Diamond Plate Alum.	18.1
5030	.125 Smooth Alum.	21.0
5540	14 Gauge "Bright" S.S.	30.4



**24H X 12-1/2W X 45FL  
SINGLE TIRE, FULL RADIUS**

PART#	DESCRIPTION	WT.
5005	.090 Smooth Alum. w/Ribs	9.2

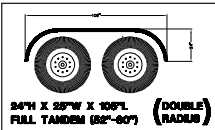

**24H X 25W X 10FL (DOUBLE)  
FULL TANDEN (60°-60°) (DOUBLE RADIUS)**

PART#	DESCRIPTION	WT.
5003	.090 Smooth Alum. w/Ribs	32.2
5013	.090 Smooth Alum.	30.9
5023	.100 Diamond Plate Alum.	38.9
5033	.125 Smooth Alum.	42.7
5543	14 Gauge "Bright" S.S.	61.5

**\*Fenders sold as single units, order two for a set.**

*Must be installed to Merritt specifications, with a Merritt Mounting Kit.*

**CAUTION:** Fenders are not to be used as steps or load bearing surfaces.

**NOTE:** Modifications of the fenders are at the discretion, responsibility, and risk of the installer.

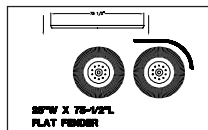

**25W X 75-1/2FL  
FLAT FENDER**

PART#	DESCRIPTION	WT.
5025	.090 Smooth Alum. w/Ribs	18
5026	.090 Smooth Alum.	17.4
5027	.100 Diamond Plate Alum.	20.9
5028	.125 Smooth Alum.	24.1
5549	14 Gauge "Bright" S.S.	34.9

Call the Merritt Customer Service Team with questions & clarification. 800.525.0107

## Deep Drop, Super Duty Fenders

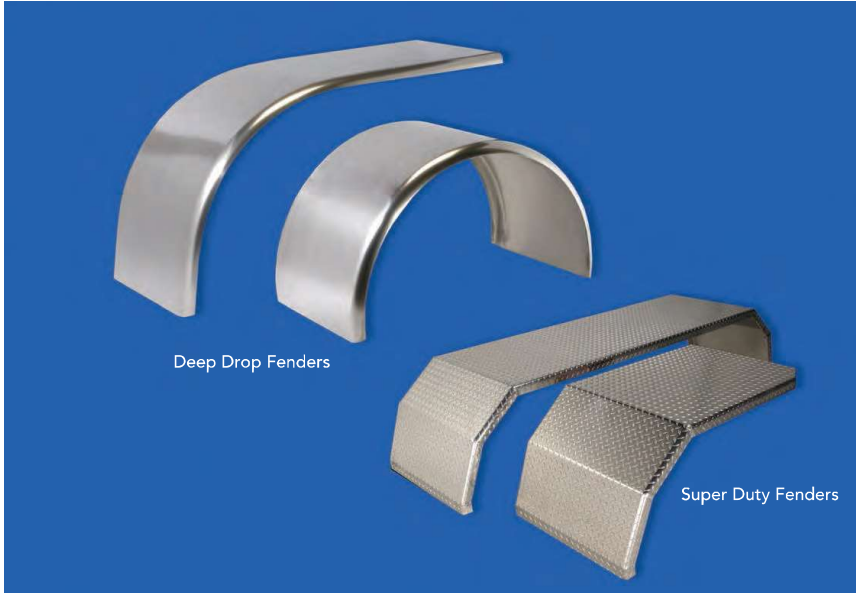

- **Deep Fenders – New style fenders:** Deep Drop Curved an addition 5" on the radius, which follows the tire radius. Deep Drop Straight with additional 5" added to the bottom of the radius - but continues straight down. Get that custom look at a standard price.
- Different styles and materials to choose from, allowing you to pick the "look" you want.
- Aluminum available in .090, .100DP or .125 thickness.
- 304 14ga stainless steel, #8 polish for strength and bright finish.
- Design a mounting style that will work for your truck.
- Super Duty models available for those rough applications.
- All Super Duty models are gusseted for added strength and long life.

Models and/or Specifications Subject to Change Without Notice.





## RADIUS WRAP AND DROP FENDERS

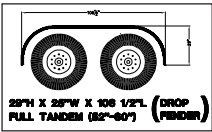

PART#	DESCRIPTION	WT.
5212	.090 Smooth Alum. w/Ribs	34.0
5222	.100 Diamond Plate Alum	42.9
5232	.125 Smooth Alum.	47.1

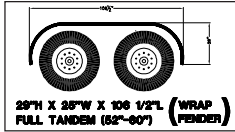

PART#	DESCRIPTION	WT.
5213	.090 Smooth Alum. w/Ribs	31.9
5223	.100 Diamond Plate Alum	38.3
5233	.125 Smooth Alum.	44.2
5547	14 Gauge "Bright" S.S.	64.1

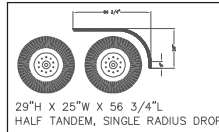

PART#	DESCRIPTION	WT.
5210	.090 Smooth Alum. w/Ribs	30.9
5220	.100 Diamond Plate Alum	38.9
5230	.125 Smooth Alum.	42.7

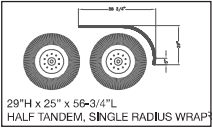

PART#	DESCRIPTION	WT.
5211	.090 Smooth Alum. w/Ribs	15.1
5221	.100 Diamond Plate Alum	18.1
5231	.125 Smooth Alum.	21.0
5546	14 Gauge "Bright" S.S.	30.4

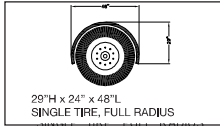

PART#	DESCRIPTION	WT.
5214	.090 Smooth Alum. w/Ribs	17.6
5224	.100 Diamond Plate Alum	22.0
5234	.125 Smooth Alum.	24.3
5548	14 Gauge "Bright" S.S.	34.8

**\*Fenders sold as single units, order two for a set.**

Must be installed to Merritt specifications, with a Merritt Mounting Kit.

**CAUTION:** Fenders are not to be used as steps or load bearing surfaces.  
**NOTE:** Modifications of the fenders are at the discretion, responsibility, and risk of the installer.

## SUPER DUTY FENDERS

PART#	DESCRIPTION	WT.
179	Full Fender, Tandem Axle 52" to 60"	54
180	Full Fender, Tandem Axle 60" to 66"	38.9
177	Half Fender	42.7

Fenders sold as single units, order two for a set.

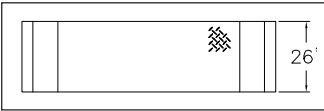

- Extra strong design, made of 1/8" thick, diamond plate aluminum alloy, designed with a double break and reinforcing gussets, allowing for added strength and longer life!
- Bright, diamond plate finish – keeps looking good, even in hard use!
- Half fenders have the same strong design and material specifications as the full fenders!

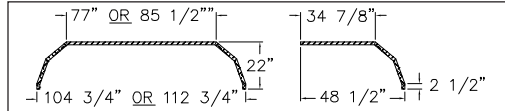

Call the Merritt Customer Service Team with questions & clarification. 800.525.0107

## Poly-Fenders

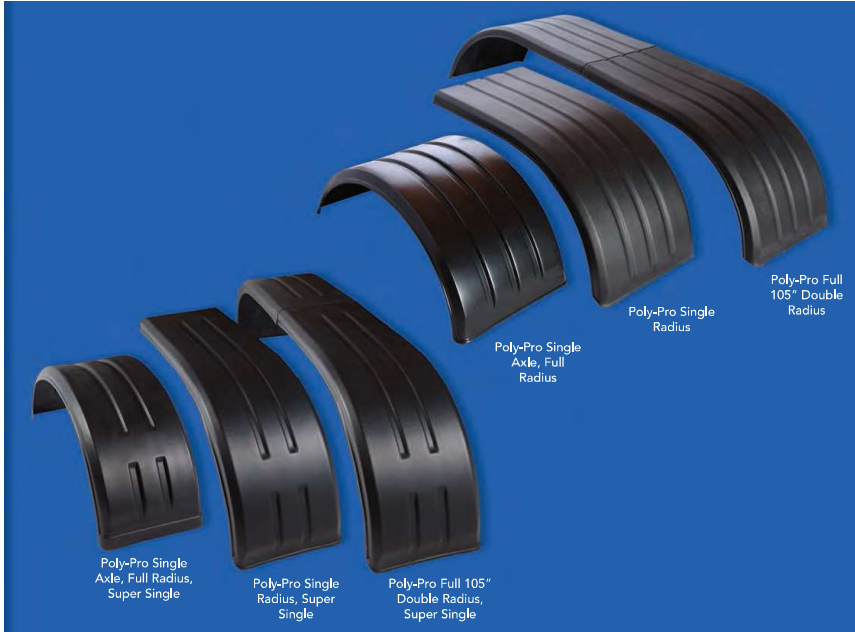

- Heavy duty, HDPE–High Density Polyethylene Flexible, with UV protection.
- Packaged as sets – two fenders per package.
- Full fender is bolted together on the middle.
- Currently six models available.
- Very flexible, low damage fender. Low cost – long life.
- Stocked in our warehouse group for fast and economical delivery.
- Use our market tested and easy to install “E-Z Mount” brackets to mount the Poly-Pro Fender.
- Standard Fender is 25” wide Super Single Fender is 18” wide.

Models and/or Specifications Subject to Change Without Notice.



**POLYETHYLENE FENDERS**

PART#	DESCRIPTION	WT.
5344-2	Poly-Pro Single Axle, Full Radius, High Density Polyethylene Black Non-Paintable Set of 2 Ribbed	20
5340-2	Poly-Pro Half Tandem, Single Radius, High Density Polyethylene Black Non-Paintable Set of 2 Ribbed	30
5343-2	Poly-Pro Full Tandem, Double Radius, High Density Polyethylene Black Non-Paintable Set of 2 Ribbed. <i>Consists of: 4-Half Fenders, 1-Nut &amp; Bolt Package</i>	45



**SUPER SINGLE POLYETHYLENE FENDER**

PART#	DESCRIPTION	WT.
5345-2	Poly-Pro Single Axle, 18" Wide Full Radius, High Density Polyethylene Black Non-Paintable Set of 2 Ribbed	20
5346-2	Poly-Pro Half Tandem, 18" Wide Single Radius, High Density Polyethylene Black Non-Paintable Set of 2 Ribbed	30
5347-2	Poly-Pro Full Tandem, 18" Wide Double Radius, High Density Polyethylene Black Non-Paintable Set of 2 Ribbed. <i>Consists of: 4-Half Fenders, 1-Nut &amp; Bolt Package</i>	45

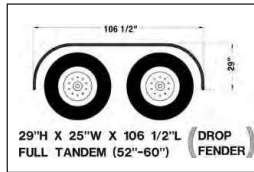
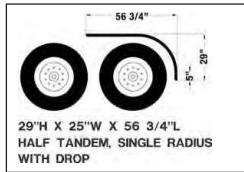
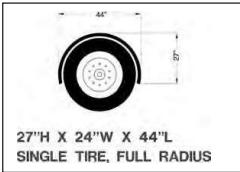

Call the Merritt Customer Service Team with questions & clarification. 800.525.0107



## E-Z Mount Fender Bracket



- 6 Models to choose from, allowing you to adapt a bracket to your application.
- 3 Adjustable models, giving you greater flexibility.
- All E-Z Fender Mount brackets have the time tested single mounting bolt. Very Quick- Very Easy!
- 3 Straight models available with rubber spacers, which provide 1" clearance between the fender and bracket, allowing dirt and gravel to pass through ... makes cleaning easier.
- All hardware is supplied with each bracket for mounting.
- Fender to bracket mounting hardware is made from stainless steel.
- Mounting instructions included with each bracket for installation.
- Stocked in all Merritt warehouse locations.

Models and/or Specifications Subject to Change Without Notice.





## ADJUSTABLE FENDER BRACKETS

### Installation Notes:

- Backing plate is designed to be used as a template to drill holes in the fender.
- When installing the 3/8" x 2-1/4" bolts, it is recommended that the bolts are not over-tightened, 10 inches/lbs. torque.
- It is necessary to bend TAB Lock-washers downward into the bolt to prevent unwinding.
- Torque 5/8" nuts to 150 ft/lbs.

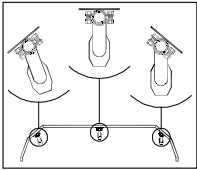

All three E-Z Fender Brackets are adjustable in length 27" to 30".

Stainless steel cap screw mounting plate bolts are included.

PART#	DESCRIPTION	WT.
567	4" Model - Black	12
568	8" Model - Black	38.9
569	10" Model - Black	42.7

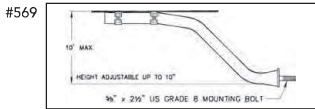
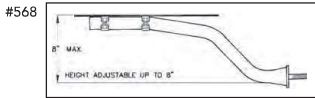
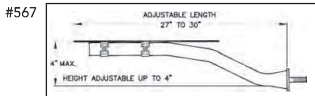

- If your E-Z Mount Bracket, mounted in the center and on the fifth wheel plate does not have full contact, the 1560 will allow a fix for this.
- Just mount with the "leg" below (see the drawing) the fifth wheel plate then mount the bracket through the plate making a 100% contact mount for the bracket.
- The 1560 package includes 2 plates, one for each side and instructions on how to use.

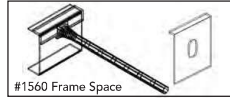

## STRAIGHT FENDER BRACKETS

This is a universal bracket designed to mount outside any fender.

### Features:

- Mounts solidly to frame with single grade 8 bolt.
- 574 mounts to the existing stub shaft for the 573 post, making those hard installation easier.
- Bracket mounts 1" off fender so rocks and gravel can pass through.

PART#	DESCRIPTION	WT.
573	Mounting Post	7
573-2	Mounting Post - Zinc Plated	5
574	Post Mount Bracket - Chrome	8
575	Straight Bracket - Black	12
576	Straight Bracket - Chrome	12
579-2	Post Mount Bracket	7
1560	Frame Space - Black	1

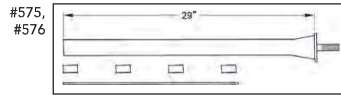
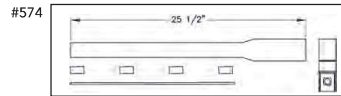
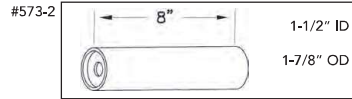
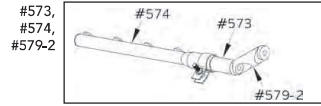

Call the Merritt Customer Service Team with questions & clarification. 800.525.0107





## Lelox Heavy Duty Fender Brackets



- Two models to choose from, allowing you to adapt a bracket to your application.
- Proven in one of the toughest environments in the world.
- Ideal for heavy duty trucks, thriving in harsh environments.
- Normal hand tools used for installation.
- Stocked in most Merritt warehouse locations.
- Each Heavy Duty Fender Mounting Kit will mount two quarter fenders or one single axle fender.  
Can be used to mount to a full fender using an E-Z Mount adjustable center bracket.
- Light, very strong, and highly durable.
- Heavy duty truck fender mounting kits include:
  - 2 off-set tube mounts (steel tube and cast aluminum boss).
  - 4 cast aluminum mounting brackets that securely fasten onto the tube and the fender.

Models and/or Specifications Subject to Change Without Notice.





**OFFSET PIPE FENDER BRACKETS**

Offset Pipe Fender Bracket is designed to mount outside any fender.



Offset chassis pipe.

**Features:**  
Offset chassis pipe mounts solidly to frame with single grade 8 bolt.

- It is necessary to bend TAB Lock-washers downward into the bolt to prevent unwinding.
- Torque 5/8 Nyloc nuts to 150 ft./lbs.

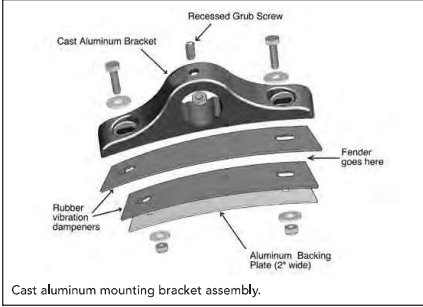

Cast aluminum mounting bracket assembly.

**Features:**  
Cast Aluminum Brackets mount to the fender as shown, secure the Grub Screw to the pipe shaft, making those hard installations a breeze.

- Mounting bracket backing plate can be used as a template to drill holes in fender.
- When installing the 3/8" x 2-1/4" bolts, it is recommended that the bolts are not over tightened, 10 inch lbs. torque.
- Secure mounting bracket to chassis pipe/tube using "Grub Screw" and 3/8" conelok nut.

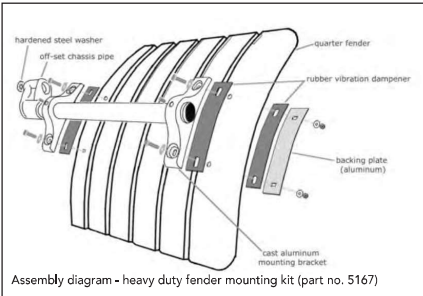

Assembly diagram - heavy duty fender mounting kit (part no. 5167)

**E-Z HD FENDER MOUNTING KITS**

PART#	DESCRIPTION	WT.
5167-2	2 mounting tubes, 4 cast, curved fender brackets and mounting hardware	24
5168-2	2 mounting tubes, 4 cast, straight fender brackets and mounting hardware	24



Call the Merritt Customer Service Team with questions & clarification. 800.525.0107

## Quarter Fenders: Stainless Steel & Poly



- Two stainless steel alloys to choose from:  
#304 – a longer lasting alloy or #430 – a more affordable alloy.
- Both alloys are polished to a high degree of luster for a bright and good looking addition to your truck.
- Three sizes of fenders available in stainless steel: 24", 27" or 29". You can select the length you need.
- Quarter fender kits include:  
2 quarter fenders, 2 top flaps, 2 mounting clamps, nut and bolt package.
- The black poly fender is made of thick, tough polymer for a long life.
- Quarter Fenders are stocked in our 13 warehouse locations, for quick delivery to you.
- Service and support that you expect from the Merritt family of products.

Models and/or Specifications Subject to Change Without Notice.

**430 Stainless steel –  
ROUND TUBE MOUNT**

PART#	DIM: Length x Width	WT.
5070-2	24" L x 24" W	33
5072-2	24" L X 27" W	34
5074-2	24" L X 29" W	35

**304 Stainless steel –  
ROUND TUBE MOUNT**

PART#	DIM: Length x Width	WT.
5080-2	24" L x 24" W	33
5082-2	24" L X 27" W	34
5084-2	24" L X 29" W	35

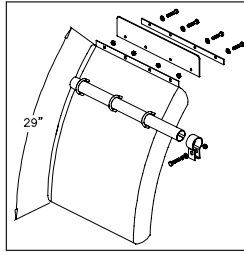
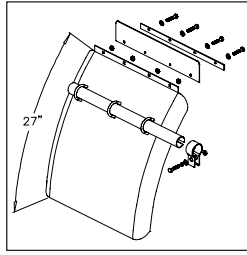
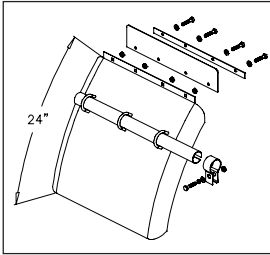

**BLACK POLY-ROUND TUBE MOUNT**

PART#	DIM: Length x Width	WT.
5060-2	24" L x 24" W	34



**MOUNTING POST – ZINC PLATED**

PART#	DESCRIPTION	WT.
573-2	Packed 2 pair	5

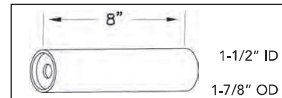

Call the Merritt Customer Service Team with questions & clarification. 800.525.0107

Models and/or Specifications Subject to Change Without Notice.